

HTemp-485 Box2

Temperature and humidity sensor for indoor use communicating over the RS-485 bus with a simple communication protocol



Device description

The **HTemp-485** device is a temperature and humidity sensor which communicates over the RS-485 bus. The sensor is designed for indoors vertical wall mounting.

The measured temperature is transmitted over a simple text protocol in °C. Up to 26 sensors of this kind or 32 sensors at all can be connected on a 4-wire bus. Two wires are used for the RS-485 bus, the other two to power the sensor. The sensors can be powered from an external independent power source and can be connected only with the remaining wires of the RS-485 bus. The RS-485 bus line can be as long as 1200 m.

The temperature sensor uses an integrated element with an accuracy of $\pm 0,5^{\circ}\text{C}$ to measure the temperature. The humidity is also measured by an internal element with an accuracy $\pm 2\%$. The Htemp-485 device has an indicator, which blinks to signalize whether the device is measuring the temperature or humidity. To preserve the simplicity of the communication protocol and the compatibility with the Temp-485 sensor device, the measurement of the temperature and the humidity is done as independent measurements, each of them having different RS-485 address.

To minimize the influence of the heat losses from the power supply and to have more possibilities of powering the sensor is equipped with a switching power supply.

Basic features

- Measurement range of relative humidity 0% to 100%.
- Temperature range -10°C to $+70^{\circ}\text{C}$.
- The addresses of the sensors can be set with jumpers, or through the terminal in the SETUP mode.
- Every sensor is calibrated.
- RS-485 communication.
- Light indicator for the measurement.
- Simple communication protocol.
- Can be easily installed on the wall.
- Minimal current consumption, power supply with unstable voltage.
- The sensors are designed to work with the SNMP thermometer Poseidon.
- Temperature measurement is separated from the circuit.
- Possibility to choose the RS-485 termination with a DIP switch.

Applications

- Large temperature measuring systems.
- Industrial measurements and regulations.
- Temperature measurement of storehouses, manufacturing and dwelling premises.
- Connecting the device with Poseidon – it can measure in technological premises and the data can be transferred over Ethernet.

Parameters

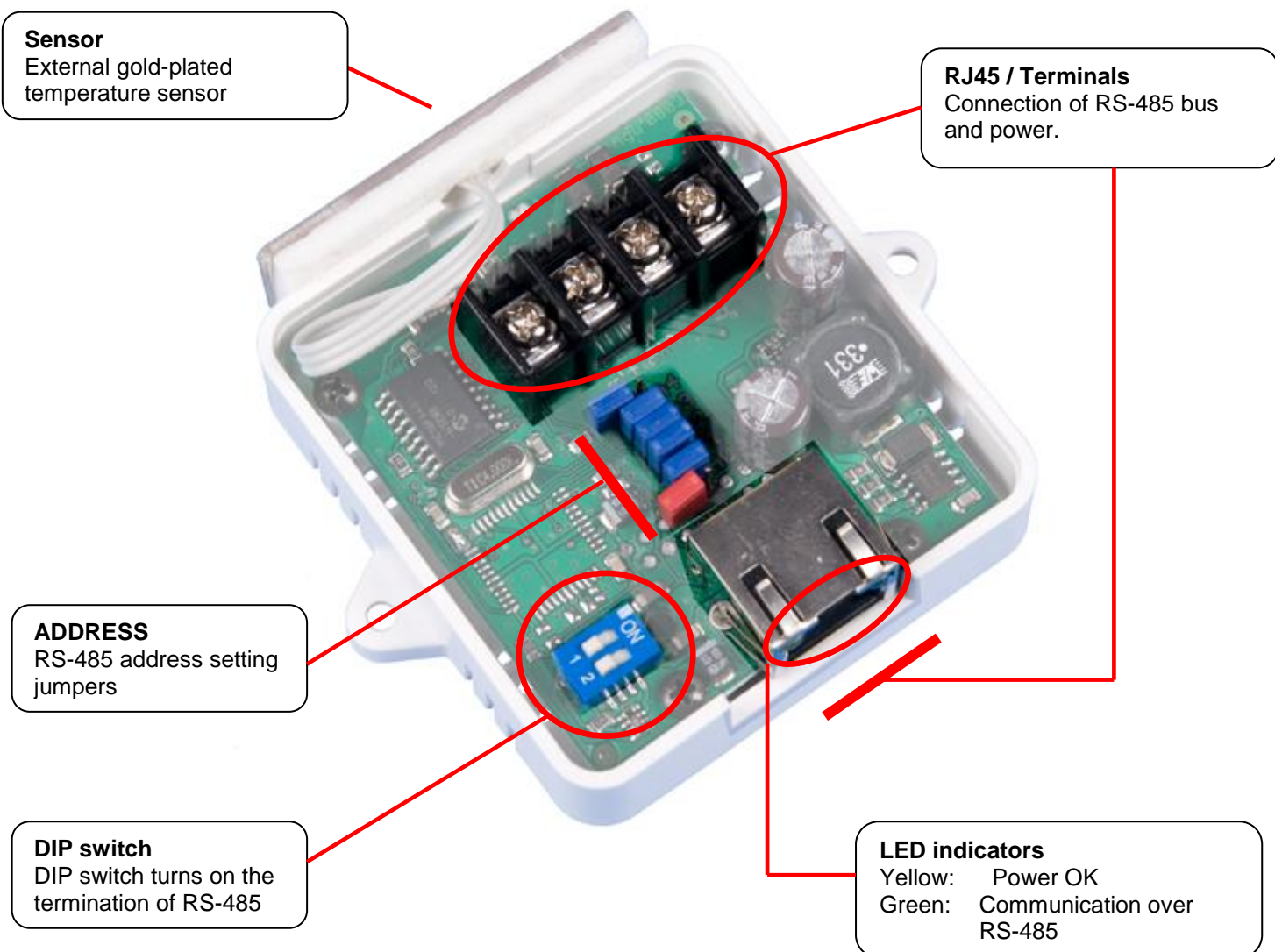

Measured temperature range..... -10°C up to +70°C
 Temperature measurement accuracy..... +/- 0,5 °C (resolution 0,01°C)
 Measuring element:.....DS18B20

Measured humidity range0% to 100%
 Accuracy of measured humidity:.....±2% within the range 0% - 90%
 (within range 15°C - 30°C)

Measuring element:..... polymeric sensor

Setting RS-485 address..... Jumper or SETUP mode

Power voltage..... +8V to +30V DC, polarity reversing protection
 Power consumption:..... Typ. 10 mA, max. 50 mA (RS-485 transmit)

Wire connection Terminal board / RJ45

Outer box dimensions: 80 x 64 x 67 mm (IP20)

Wall mounting: Mounting the sensor on the wall by two screws

Sensor's communication address: The address character is always in the range "A/a" .. "Z/z" (with exception of "T/t")

RS-485 address assign: With jumpers (A .. Z positions) or in SETUP mode,
 + Setting with jumpers Value on jumpers "**A/a**" to "**Z/z**"
 + Setting in SETUP mode Using simple terminal over RS-485 in SETUP mode, Jumpers must be set to "Addr by SETUP" value

RS-485 termination Optional (DIP1 and 2), always 10 kΩ resistors for idle state of the line

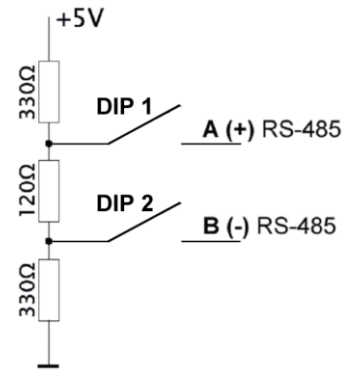

Setting sensor address

The temperature sensor and the humidity sensor act to the RS-485 link protocol as they were two different independent devices. The Sensor uses **two addresses over the link RS-485** and answers to the requests at both addresses.

Using jumpers you can set only one address in the range “A”...“Z” (except “T”). This address is then used to address the temperature measurement.

The second address, for the humidity measurement, is derived as the respective lower case character. The humidity sensor’s address character is always in the range “a”...“z” of addresses (except “t”).

- Both addresses can be set in the SETUP mode as well, but the address configured in such a way, can be used only if the array of jumpers is set to „Adr by SETUP“ value. This address can be configured also by commands over the RS-485 link.
- If the address in the „A/a“... „Z/z“ range is set in the array of jumpers, then this address is always used!

A4	A3	A2	A1	A0	Address	A4	A3	A2	A1	A0	Address	A4	A3	A2	A1	A0	Address
X	X	X	X	X	Adr by SETUP	X	O	X	O	O	K/k	O	X	O	O	X	V/v
X	X	X	X	O	A/a	X	O	O	X	X	L/l	O	X	O	O	O	W/w
X	X	X	O	X	B/b	X	O	O	X	O	M/m	O	O	X	X	X	X/x
X	X	X	O	O	C/c	X	O	O	O	X	N/n	O	O	X	X	O	Y/y
X	X	O	X	X	D/d	X	O	O	O	O	O/o	O	O	X	O	X	Z/z
X	X	O	X	O	E/e	O	X	X	X	X	P/p	O	O	X	O	O	Adr by SETUP
X	X	O	O	X	F/f	O	X	X	X	O	Q/q	O	O	O	X	X	Adr by SETUP
X	X	O	O	O	G/g	O	X	X	O	X	R/r	O	O	O	X	O	Adr by SETUP
X	O	X	X	X	H/h	O	X	X	O	O	S/s	O	O	O	O	X	Adr by SETUP
X	O	X	X	O	I/i	O	X	O	X	X	Adr by SETUP	O	O	O	O	O	Adr by SETUP
X	O	X	O	X	J/j	O	X	O	X	O	U						

Note: O (open) = jumper disconnected, X (close) = jumper connected
 Character „A/a“ means, that address „A” is used to measure temp. and „a” to measure humidity
 The address “T/t” is restricted, if you jumper it, it’s used address by the SETUP.

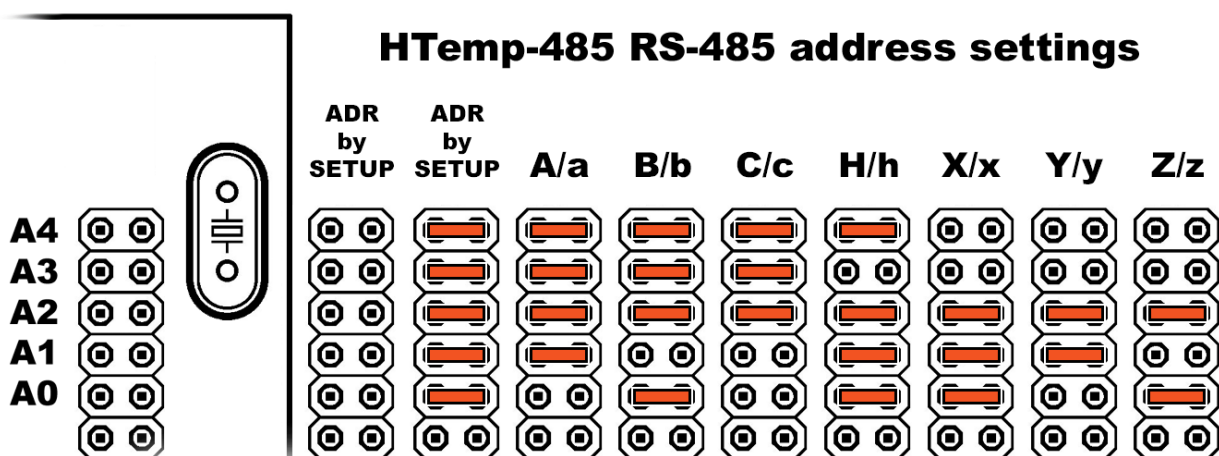

Sensor SETUP mode

For more complicated settings the sensor uses the simple SETUP mode through the terminal via RS485. For common usage you do not need to use the SETUP mode. The jumpers A0 – A4 will be enough to set the addresses of the sensors.

Activation of Setup mode

- Set the jumpers to the „Adr by SETUP“ position (for ex. all or none occupied).
- Be sure that only in one of the sensors in the RS-485 link, the jumpers are set to the position „Adr by SETUP“.
- Connect using any terminal at the serial port (9600 8N1).
- Switch on the sensor’s power supply (Indicator blinks 2x)
- During the first 30 sec. after the device is on type at least 30 times the character “u” (lower case “u”) (the indicator lights red).
- At the terminal the SETUP mode will appear, as you can see from the figure.

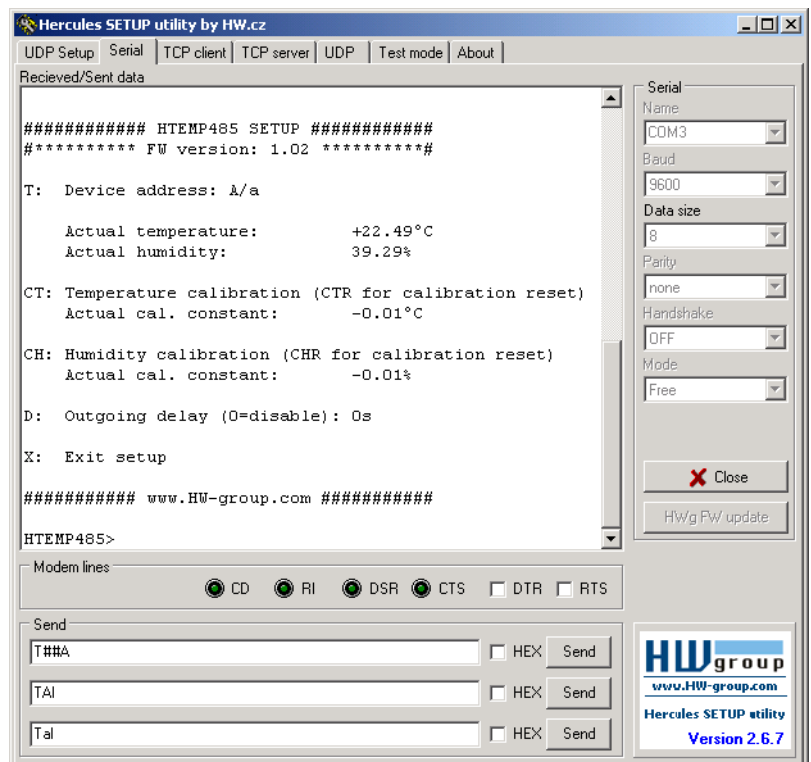

If case you cannot activate, check if:

- You have powered the sensors (the LED is lit)?
- You have set the jumpers to the combination „Adr by SETUP“ (after being switched on the LED blinks 2x)?
- The terminal is set in the right way (9600 8N1).
- The converter RS-232 / RS-485 is working? Does it support switching of directions?
- Did you really type circa 30 times the character “u” (lower case u)?
- You did not spend more than 30 seconds after the device was switched in to get at the SETUP mode.

The SETUP mode

In the following frame a text from the terminal screen can be seen, when the sensor is in the Setup mode. By typing the first character of the line you can call the function which sets the respective parameter.

```
##### HTEMP485 SETUP #####
#***** FW version: 1.02 *****#

T: Device address: A/a
    Actual temperature:      +22.55°C
    Actual humidity:        41.49%

CT: Temperature calibration (CTR for calibration reset)
    Actual cal. constant:   -0.01°C

CH: Humidity calibration (CHR for calibration reset)
    Actual cal. constant:   -0.01%

D: Outgoing delay (0=disable): 0s

X: Exit setup

##### www.HW-group.com #####

HTEMP485>
```

T: Device address

You can set the address of the temperature sensor in the allowed range of characters “A”.. “Z” with exception of “T”. This value will be taken into account, only if the jumpers (A0 through A4) are set to the position „Adr by SETUP“. Otherwise the sensor will use (and display at the SETUP screen mode) the value of the address that is set by the jumpers.

CT: Temperature calibration

Calibrates the measurement of the temperature by shifting the measuring curve.

CH: Humidity calibration

Calibrates the measurement of the humidity by shifting the measuring curve.

D: Outgoing delay

Sends to the RS-485 line, in preset intervals [1 ... 5000] seconds, information about the value of the temperature and humidity in the format: (for ex. for the address A/a “*A+022.62C*a039.19%<CR>” where <CR> is the 0D hex value).

By default the function is switched off = interval set to 0.

X: Exit setup

Exits from the SETUP mode and continues in normal mode.

Example: To set up the address of the sensor at „Z/z“ type at the terminal „Z<CR>” .

Communication protocol

The sensors operate in a question-answer mode. The maximum response time is 50 ms.

Communication bus.....	RS-485
Range of addresses.....	“A” to “Z” (26 addresses) – addresses for the temp. sensor “a” to “z” (26 addresses) – addresses for the humidity sensor
Communication.....	ASCII, described below
Response time.....	max. 50 ms for a command
Max. delay between characters.....	max. 10 ms to type one character of a command
Speed.....	9600 baud
Data bits.....	8
Parity	none
Stop bits.....	1

Temperature reading

Function	Command syntax	Example
Temperature request	T<address>I	TAI
Answer from sensor (all OK)	*<address><temp><CR>	*A+025.51C
Answer from sensor (error)	*<address>Err<CR>	*AErr

<address> is a character from „A“ .. „Z“ with exception of „T“ ,

<CR> is the 0xD or 13 dec - end of line,

<temp> has the format *A+025.5C or *A+025.55C .

Humidity reading

Function	Command syntax	Example
Humidity request	T<address>I	TaI
Answer from sensor (all OK)	*<address><humidity><CR>	*a048.19%
Answer from sensor (error)	*<address>Err<CR>	*aErr

<address> is a character from „a“ .. „z“ with exception of „t“ ,

<CR> is the 0xD or 13 dec - end of line,

<humidity> has the format *a048.19% .

Device identification

Function	Command syntax	Example
Device type request	T<address>?	TA?
Answer from sensor (all OK)	*<address><Identificat><cr>	*ATHMP 2

<Identificat> HTemp-485 (temp. sensor)..... "THMP 2"

zHTemp-485 (humidity sensor)..... "HTMP 2"

Note: Number 2 gives the FW version of the sensor.

Sensor address setup

This function works only in case that the sensor has set the jumpers at the combination „Adr by SETUP“. If the address is set by jumpers manually, the sensor ignores the command.

At the RS-485 line must be just one sensor, to be set, otherwise there will be a collision.

Function	Command syntax	Example
Address change	T#<new address>	T#A
Answer from sensor (all OK)	*<new address>OK<CR>	*AOK
Answer from sensor (error)	*<old address>Err<CR>	*BErr

<address> is a character from „A“ .. „Z“ and „a“ .. „z“ with exception of „T“
 <CR> is the 0xD or 13 dec - end of line,

Note: You are setting **HTemp-485** address, which uses two addresses (one for temperature sensor, second for humidity sensor). By this command you only set the address in this form: capital letter, second address (same letter, but small) is set automatically.

Notes

- If the device does not answer in the terminal mode, the cause must be the typing delay between the character. If you send the commands from the keyboard by typing them, because the delay between characters is too long then the sensor does not admit this kind of command. We recommend you to prepare the commands as sequences at „makro“ and send them at once. The following figures show where you can find the makro in the recommended software Hercules and Terminal.
- If you set the address with the command „T#A“, that contains in it the character „#“, is necessary to write two times this character, because this character is used very often in makro to insert decimal values of characters.

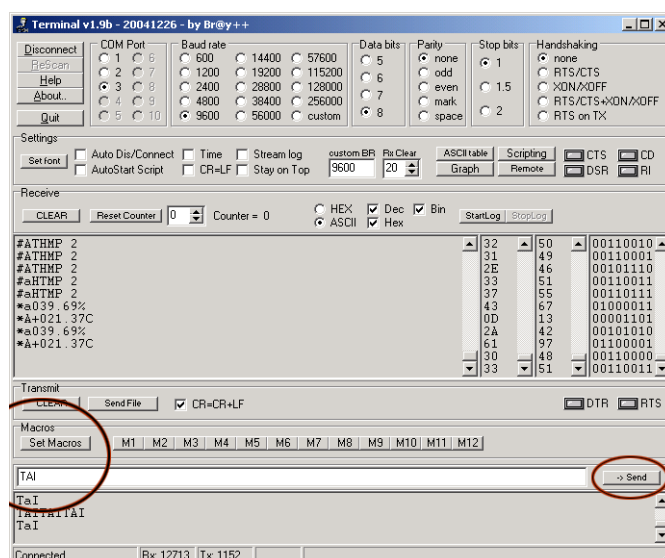
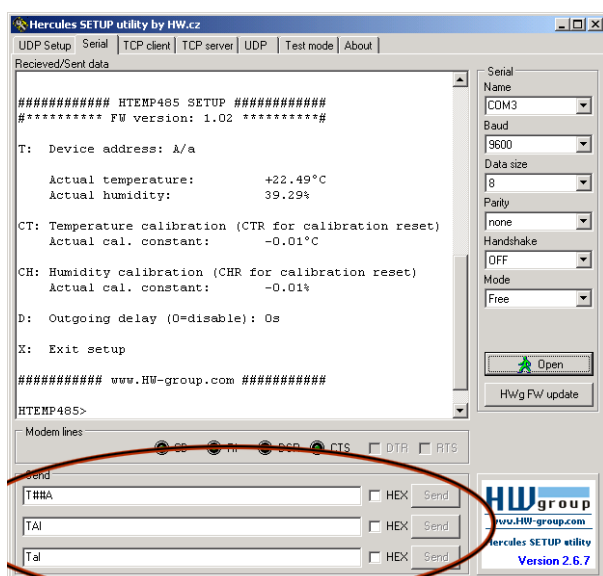

How to connect HTemp-485 at Poseidon

- 1) Connect the HTemp-485 sensor, as it is shown in the figure.
- 2) If the sensor is the last device on the RS-485 bus, set both DIP switches DIP1=ON, DIP2=ON.
- 3) Setup by jumpers the address of the sensor, with a value that is not used by any other sensor at the RS-485 line.
- 4) Check if the Poseidon has DIP2=ON, that is, the RS-485 line is turned on.
- 5) Connect the terminal SETUP mode of the thermometer device Poseidon, which can be done in two ways:
 - **RS-232 Setup** (Poseidon DIP1=ON, Port2 connected to PC over RS-232, Poseidon needs to be turned off and on)
 - **TCP Setup at port 99** (If it is allowed and Poseidon DIP3=Off, it will be enough to Telnet at port 99)

In the Setup mode choose **(3).. RS-485(Temp-485)** and start-up the sensor auto-detection, which finds and displays the addresses of all sensors founded. The address will be displayed twice, in upper and in lower case characters. If Poseidon displayed the address which is the same with the address written at the back of the sensor then everything is fine.

- 6) Choosing **(x) eXit** you exit from the Setup mode and you should be able now to see the value of the sensor in the WWW page (type in the browser's addr. field the IP address of Poseidon).

Tips and notes

- **Which cables to use?**

The most economical solution of wiring is the using a twisted pair (TP) cable, which is used for wiring computer networks. In practice just two pairs (out of four) are mostly used therefore one of the pairs can be used for data transmission over RS-485. For the supply we recommend to assign one pair for the positive and one pair for the negative pole.
- **Sensor's positioning**

It is supposed that the devices are mounted in the wall with the measuring sensor downward.
- **Reaction time of the humidity sensor**

You have to take into account that if the humidity arises, the sensor reacts almost immediately, but if positioned downward the reaction will be slower.

Address jumpering

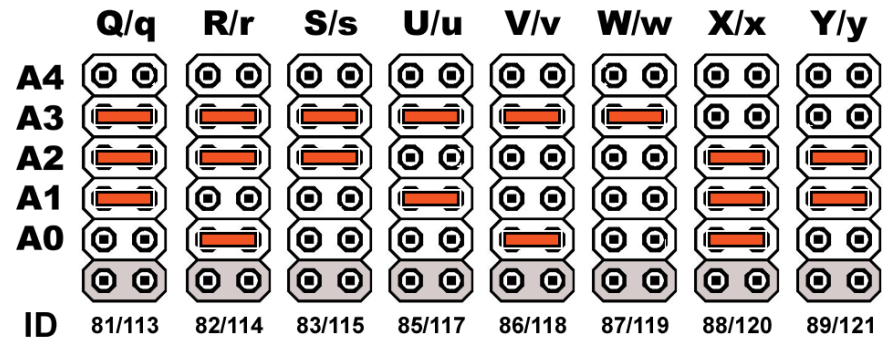
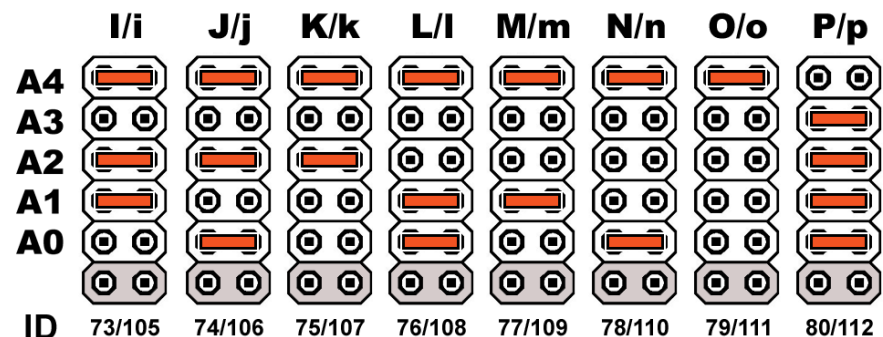
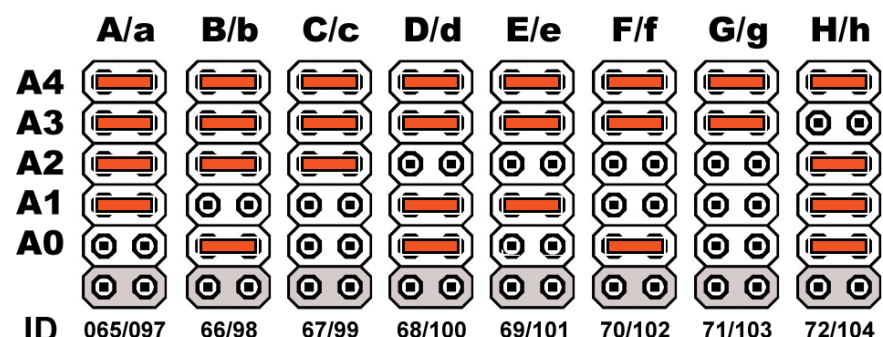
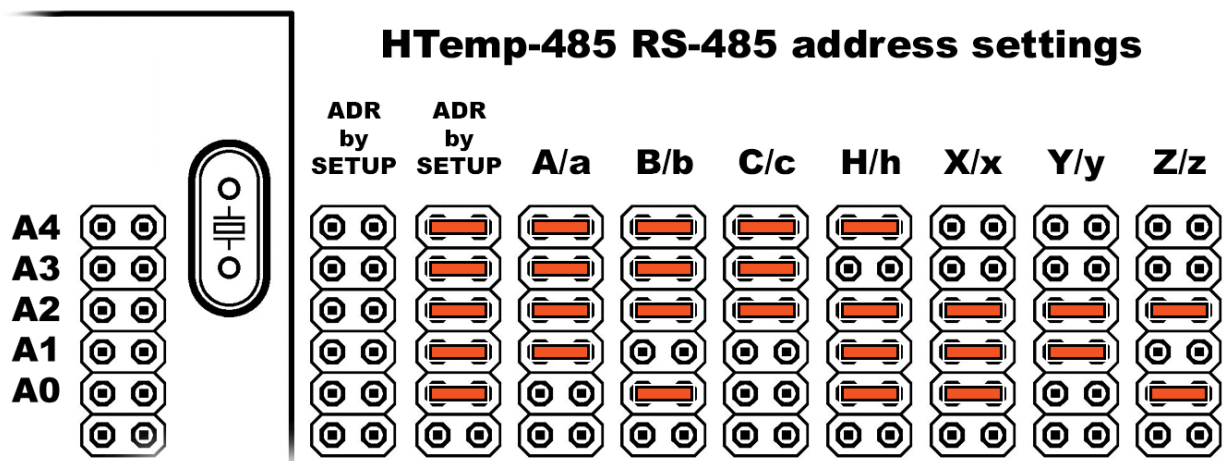

Sensor connection

HTemp-485 Box2 temperature and humidity sensor can be connected to RS-485 bus in various methods:

- **Direct connection over 4 conductors**

For use in extensive storage buildings. It requires experience with RS485 bus. We recommend this option to very skilled users or installation companies.

- **RJ45**

Sensors connection through S-Hub or one thermometer directly to RJ45 connector with RS-485 on Poseidon unit.

- **RJ45 / directly - Connection of more sensors via S-Hub**

You do not need Poseidon B-Cable to connect sensor over TP cable to RJ45. TP cable with RJ45 connector can be connected directly to terminal board.

Use "LAST" configuration if you connect only one sensor(connection detail).

In case you connect sensors to S-Hub unit, use "MIDDLE" (connection detail) configuration for every sensor except the last one:

- Terminals: GND (-) = RJ45: 7 (brown/white)
- Terminals: Vcc (+) = RJ45: 8 (brown)
- Terminals: RS-485 (A) = RJ45: 5 (blue/white) + 6 (green)
- Terminals: RS-485 (B) = RJ45: 4 (blue) + 5 (green/white)

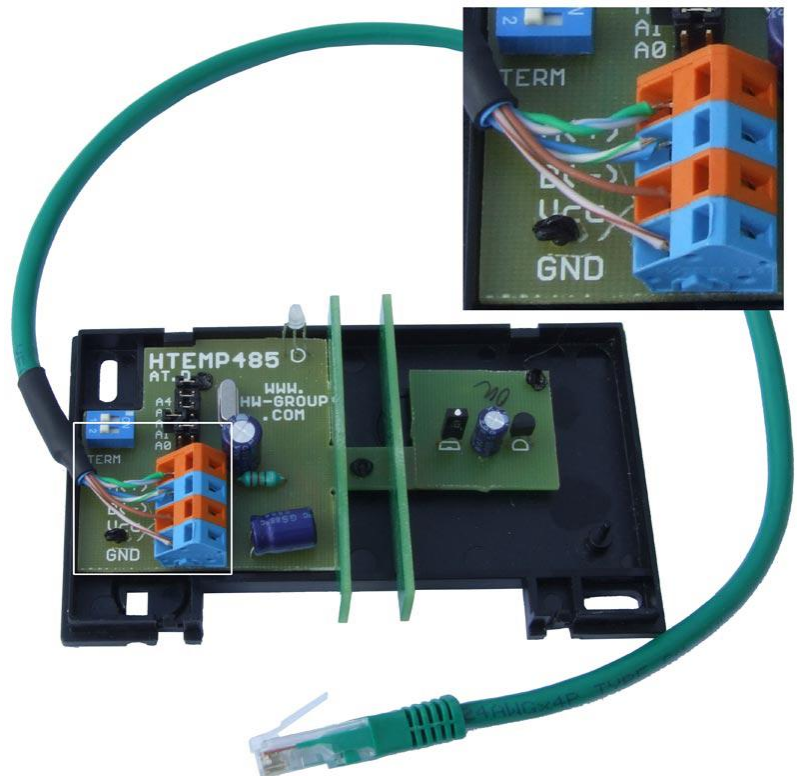

There is an older version of sensor on the picture but the cable connection is the same.

You can find direct RJ45 cable connection details on the bottom of the Poseidon B-Cable page.