

SDM120C

SMART MINI POWER

DIN Rail Smart Energy Meter for Single Electrical Systems



USER MANUAL

2014 V1.0

Important Safety Information is contained in the Maintenance section. Familiarize yourself with this information before attempting installation or other procedures.

Symbols used in this document:



Risk of Danger: These instructions contain important safety information:
Read them before starting installation or servicing of the equipment



Caution: Risk of Electric Shock

1 Introduction

This document provides operating, maintenance and installation instructions. The unit measures and displays the characteristics of single phase two wires (1p2w) supply, including voltage (V), current (A), power (W), frequency (Hz), power factor (PF), active energy (kWh). The non-displayed parameters of imported and exported energy can be read via RS485 communication with corresponding register.

The meter is self-power supplied when it's connected with single phase two wires system, does not need to input an auxiliary power supply. It's directly connected, does not need to connect with external current transformer (CT). Built-in interfaces provide pulse and RS485 Modbus RTU outputs.

1.1 Unit Characteristics

The Unit can measure and display:

- Voltage
- Current
- Power
- Frequency
- Power factor
- Active energy

Two pulse outputs indicate real-time energy measurement. An RS485 output allows remote monitoring from another display or a computer.

1.2 RS485 Serial – Modbus RTU

This uses an RS485 serial port with Modbus RTU protocol to provide a means of remotely monitoring and controlling the Unit

1.3 Pulse output

This provides two pulse outputs, Pulse 1 is settable and can be set into four different energy output modes:

Mode 1	0.001kWh/imp (default)
Mode 2	0.01kWh/imp
Mode 3	0.1kWh/imp
Mode 4	1kWh/imp

Also, pulse 1 can be set into three types of pulse output modes.

Mode 1: Measures imported energy. Total energy = imported energy (default)

Mode 2: Measures imported energy and exported energy.

Total energy = imported energy + exported energy

Mode 3: Measures imported energy and exported energy.

Total energy = imported energy - exported energy

Pulse 2 is fixed as 1000imp/kWh and cannot be set.

2.Specifications

2.1 Performance criteria

Operating humidity	≤ 85%
Storage humidity	≤ 95%
Operating temperature	-25° C - +55° C (3K6)
Storage temperature	-30° C - +70° C
International standard	IEC 62053-21
Accuracy class	0.5 or 1.0
Protection against penetration of dust and water	IP51
Insulating encased meter of protective class	II

2.2 Meter specifications

Nominal voltage(Un)	230V AC 110V AC
Operational voltage	0.7-1.3Un
Insulation capabilities: - AC voltage withstand - Impulse voltage withstand	4KV for 1 minute 6kV-1.2μS waveform
Basic current(Ib)	5A
Maximum rated current(I _{max})	45A
Operational current range	0.4% Ib-I _{max}
Over current withstand	20I _{max} for 0.01s
Operational frequency range	50-60Hz ± 2%
Internal power consumption	≤ 2W / 10VA
Test output flash rate (RED LED)	1000imp/kWh
Pulse output rate	1000imp/kWh
Consumption indicator (RED LED)	Flashing at load running
Data communication port	RS485 Modbus RTU
Data save	>20 years when power off

2.3 RS485 communication specifications

Bus type	RS485
protocol	MODBUS RTU with 16 bit CRC
baud rate	1200,2400(default), 4800,9600
Address range	1-247 user settable
Bus Loading	32 meters per bus
Rage	1000M
Parity	EVEN (default)/ODD/NONE
Stop bit	1
Data bits	8

2.4 Accuracy

Voltage	0.5% of range maximum
Current	0.5% of nominal
Frequency	0.2% of mid-frequency
Power factor	1% of unity (0.01)
Active power (W)	±1% of range maximum
Reactive power (VAr)	±2% of range maximum
Apparent power (VA)	±1% of range maximum
Active energy (Wh)	Class 1 IEC 62053-21

2.5 Environment

Operating temperature	-25°C to +55°C*
Storage temperature	-40°C to +70°C*
Relative humidity	0 to 90%, non-condensing
Altitude	Up to 2000m
Warm up time	1 minute
Vibration	10Hz to 50Hz, IEC 60068-2-6, 2g
Shock	30g in 3 planes

*Maximum operating and storage temperatures are in the context of typical daily and seasonal variation.

3. Start Up Screens

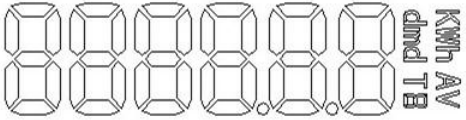
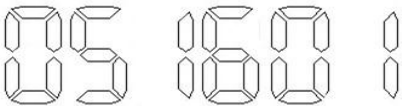
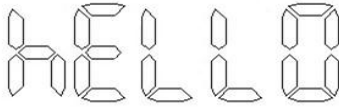
	<p>The first screen lights up all display segments and can be used as a display check</p>
	<p>The second screen indicates the firmware version number</p>
	<p>The interface performs a HELLO to welcome</p>



After a short delay, the screen will display active energy measurements.

4. Measurements and display

The buttons operate as follows:

	Press the button once effectively to scroll the display interface
	Long press the button last for 3 secs to enter the set-up model

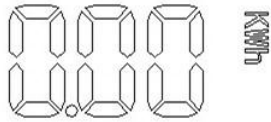
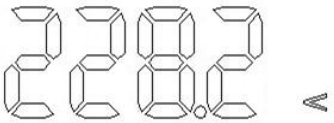
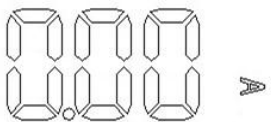
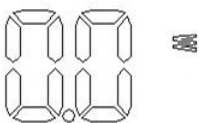
Each successive pressing of the  button selects a new range:

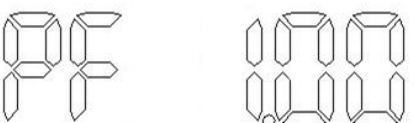
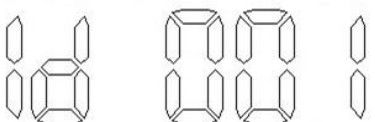
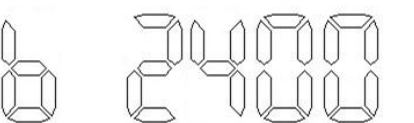
	Total kWh The default display form is X.XX,when it achieve 9.99,the display form will turn to XX.XX, then XXX.XX and XXXX.XX
	Voltage
	Current
	Power
	Frequency
	Power factor
	Meter number(meter ID) Default 001
	Baud rate Default 2400bps

5. Setting Up

To enter set-up mode, pressing the  button for 3 seconds, until the lcd display the -SET-

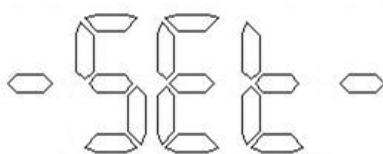

5.1 Set-up Entry Methods

After successfully enter the SET model, then the set-up can be realized via RS485 communication with the correct Modbus Protocol.

The electrical interface is 2-wire RS485, via 2 screw terminal. Connection should be made using twisted pair screened cable (Typically 22 gauge Belden 8761 or equivalent). A total maximum length of 3900 feet (1200 meters) is allowed for the RS485 network. A maximum of 32 electrical nodes can be connected, including the controller. The address of SDM120C smart meter can be set to any value between 1 and 247. Broadcast mode (address 0) is not supported.

All data values in the SDM120C smart meter are transferred as 32 bit IEEE754 floating point numbers, therefore each SDM120C smart meter value is transferred using two Modbus Protocol registers. All register read requests and data write requests must specify an even number of registers. Attempts to read/write an odd number of registers prompt the SDM120C smart meter to return a Modbus Protocol exception message.

The Modbus Protocol establishes the format for the master's query by placing into it the device address, a function code defining the requested action, any data to be sent, and an error checking field. The slave's response message is also constructed using Modbus Protocol.

Modbus Protocol function code ~~04~~03 is used to read data.

For example:

to request 01 04 00 00 00 02 CRC to read the voltage

to request 01 04 00 12 00 02 CRC to read apparent power

For example:

to request 01 10 00 14 00 02 04 40 00 00 00 CRC to set meter address as 02

(Hex 40 00 00 00 equals float 2)

to request 01 10 00 1C 00 02 04 40 00 00 00 CRC to set baud rate as 9600

(Hex 40 00 00 00 equals float 2)

5.2 The detailed register map information of SDM120C are as follows:

Part 1

*Parameters to be read by function code **04**:

Address (Register)	Input Register Parameter			Modbus Protocol Start Address Hex	
	Parameter	Units	Format	Hi byte	Lo byte
30001	Voltage	Volts	Float	00	00

30017	Current	Amps	Float	00	06
30013	Active power	Watts	Float	00	0C
30019	Apparent power	VA	Float	00	12
30025	Reactive power	VAr	Float	00	18
30031	Power factor	None	Float	00	1E
30071	Frequency	Hz	Float	00	46
30073	Import active energy	kWh	Float	00	48
30075	Export active energy	kWh	Float	00	4A
30343	Total active energy	kWh	Float	01	56

Part 2

*It needs to long press the button on meter last for 3 seconds to enter the set-up interface firstly, then the set-up can be realized via RS485 communication. After the set-up is finished, long press last for 3 seconds to exit the set-up interface

*Parameters to be setted by function code 10, and to be read by function code 03:

Address (Register)	Input Register Parameter		Modbus Protocol Start Address Hex		Description
	Parameters	Format	Hi byte	Lo byte	
40021	Meter ID	Float	00	14	Ranges from 1 to 247, and requires a restart to become effective. Default ID is 1. It can also be modified via the display set-up menus.
40029	Baud rate	Float	00	1C	0:2400bps(default) 1:4800bps 2:9600bps 5:1200bps Requires a restart to become effective.
463745	Time of display in turns	BCD	F9	00	0-30s Default 0: does not display in turns
463761	Pulse 1 output	Hex	F9	10	0000:0.001kWh/imp(default) 0001:0.01kWh/imp 0002:0.1kWh/imp 0003:1kWh/imp
463777	Measurement mode	Hex	F9	20	0001:mode 1(default) 0002:mode 2 0003:mode 3
463793	Pulse 1 output mode	Hex	F9	30	0000:Import+export energy, both LEDs of import and export energy light on(default)

					<p>0001:Import energy,only the LED of import energy lights on</p> <p>0002:Export energy,only the LED of export energy lights on</p>
--	--	--	--	--	---

6 Dimensions

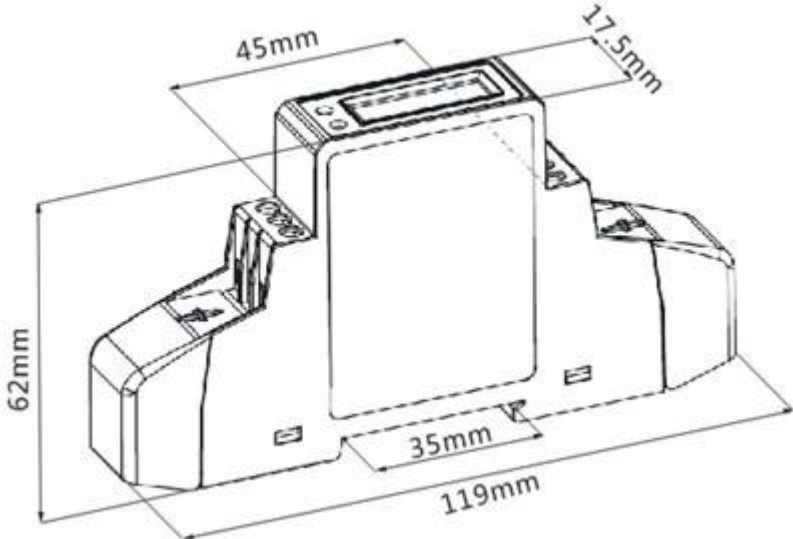

7. Installation

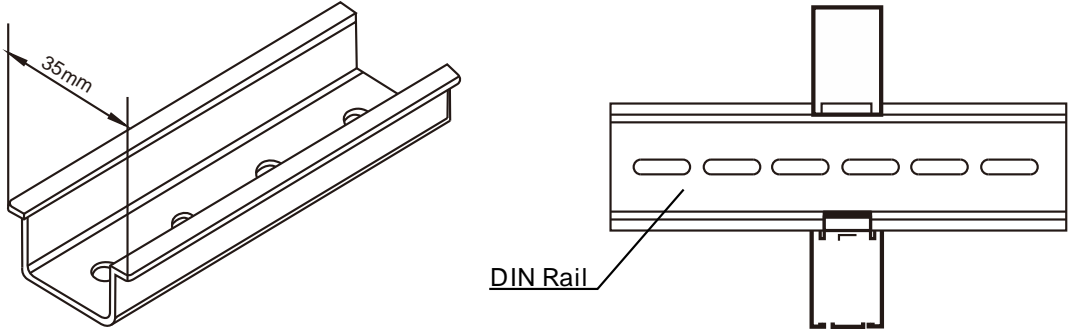

8.Wiring diagram

